

# Influence of the shape of reinforcing window profiles on the strength and torsional stiffness of windows

## Wpływ kształtu wzmacniających profili okiennych na wytrzymałość i sztywność skrętną okien

EDWARD REJMAN  
PAWEŁ BAŁON  
BARTŁOMIEJ KIEŁBASA  
ROBERT SMUSZ\*

DOI: <https://doi.org/10.17814/mechanik.2022.8-9.12>

Leading European manufacturers of profiles intended for the production of construction joinery currently use mainly PVC profiles with various configurations of external and internal shapes, allowing the production of functional products due to their intended use, shape, possibility of building them, maintaining color and maintaining low thermal transmittance coefficients of profiles. It is important to obtain high cross-sectional strengths, especially for torsion and bending. It is related to high wind loads of structures. A profile is made of a PVC with a low Young's modulus compared to other materials, and thus it has low stiffness and strength indicators. This leads to relatively easy deformation of the joinery profiles during assembly. To avoid this unfavorable effect, the PVC profiles are reinforced with steel sections. Currently, in the industry producing PVC profiles, open steel reinforcement profiles are almost exclusively used. This solution is very disadvantageous for reasons of stiffness. However, manufacturers use such profiles primarily for technological and price reasons. Closed profiles pose many technological problems in their production and are approx. 30% more expensive compared to the corresponding open profiles. This paper presents research on the use of closed steel stiffening sections in place of open profiles. The main advantage of stiffening closed profiles is many times greater bending and torsional stiffness compared to open profiles. The theoretical and experimental studies carried out for selected cross-sections have shown that the stresses in a closed profile are several times lower than in an identical open profile, and the torsional stiffness of a closed profile is even several dozen times higher than that of an identical open profile.

**KEYWORDS:** torsional stiffness, bending stiffness, window open frames, window closed frames

Czołowi europejscy producenci profili do produkcji stolarki budowlanej stosują obecnie głównie profile PVC o różnych konfiguracjach kształtów zewnętrznych i wewnętrznych, pozwalające na produkcję wyrobów funkcjonalnych ze względu na ich przeznaczenie, kształt, możliwości konstrukcyjne, zachowanie koloru oraz utrzymanie niskich współczynników przenikania ciepła profili. Ważne jest uzy-

skanie wysokiej wytrzymałości przekrojowej, zwłaszcza na skręcanie i zginanie. Jest to związane z dużymi obciążeniami wiatrowymi konstrukcji. Profil wykonany z PVC o niskim module Younga w porównaniu z innymi materiałami ma niskie wskaźniki sztywności i wytrzymałości. Prowadzi to do stosunkowo łatwego odkształcenia profili okiennych podczas montażu. Aby uniknąć tego niekorzystnego efektu, profile z PVC są wzmacniane kształtownikami stalowymi. Obecnie w branży produkującej profile z PVC stosuje się niemal wyłącznie otwarte stalowe profile wzmacniające. To rozwiązanie jest bardzo niekorzystne ze względu na sztywność. Jednak producenci stosują je przede wszystkim z powodów technicznych i kosztowych. Produkcja profili zamkniętych stwarza wiele problemów i są one o ok. 30% droższe od profili otwartych. W pracy przedstawiono badania nad zastosowaniem zamkniętych stalowych kształtowników usztywniających w miejsce profili otwartych. Główną zaletą usztywniania profili zamkniętych jest ich wielokrotnie większa sztywność giętą i skrętną w porównaniu z profilami otwartymi. Badania teoretyczne i doświadczalne wybranych przekrojów wykazały, że naprężenia w profilu zamkniętym są kilkukrotnie mniejsze niż w identycznym profilu otwartym, a sztywność skrętna profilu zamkniętego jest nawet kilkadziesiąt razy większa niż profilu otwartego.

**SŁOWA KLUCZOWE:** sztywność skrętna, sztywność giętą, ramy okienne otwarte, ramy okienne zamknięte

### Introduction

In modern, currently used construction joinery, especially windows, PVC profiles reinforced with steel sections are used. Steel sections act as stiffening elements and are made as open profiles. This is due to two facts:

- open profiles are cheaper than closed profiles,
- closed profiles are much more complex in terms of technology and only few companies can afford to make such structures.

The main disadvantage of the steel elements that stiffen the window structure is that they cause large thermal bridges. This is mainly due to the high thermal

\* Dr inż. Edward Rejman – [erejman@prz.edu.pl](mailto:erejman@prz.edu.pl), <https://orcid.org/0000-0003-4716-7613> – Rzeszów University of Technology, Rzeszów, Poland; F.H.U. ATUT Marek i Alicja Janeczek Sp.J., Mielec, Poland  
Dr inż. Paweł Bałon – [balonpawel@gmail.com](mailto:balonpawel@gmail.com), <https://orcid.org/0000-0003-3136-7908> – AGH University of Science and Technology, Kraków, Poland; F.H.U. ATUT Marek i Alicja Janeczek Sp.J., Mielec, Poland  
Mgr inż. Bartłomiej Kiełbasa – [bartek.kielbasa@gmail.com](mailto:bartek.kielbasa@gmail.com), <https://orcid.org/0000-0002-3116-2251> – F.H.U. ATUT Marek i Alicja Janeczek Sp.J., Mielec, Poland  
Dr hab. inż. Robert Smusz – [robsmusz@gmail.com](mailto:robsmusz@gmail.com), <https://orcid.org/0000-0001-7369-1162> – Rzeszów University of Technology, Rzeszów, Poland; F.H.U. ATUT Marek i Alicja Janeczek Sp.J., Mielec, Poland

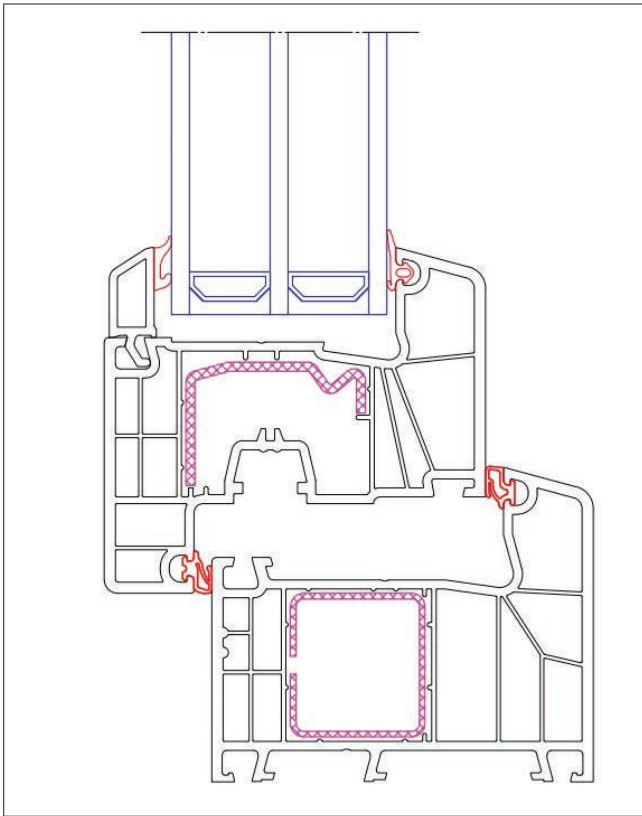

Fig. 1. A typical window profile with metal open reinforcements

conductivity of the steel and the large dimensions of the chambers in which the sections are placed. This causes the intensification of convective heat exchange. The considerable sizes of the chambers result from the necessity to obtain sufficiently high bending strength indexes and bolting complete sections used for frames. As a result of assembly and operational loads, the supporting profiles of window frames are subject to significant deformation. This causes leaks and air infiltration inside the building. Profile deformations result from their relatively low torsional and bending stiffness as well as faulty fixing of the profiles to the window frame, which is particularly visible in the case of large window surfaces and the door.

A typical window profile consists of a prismatic PVC jacket with a generatrices parallel to the bar axis and ribs transverse to this axis. The bar is most often made in such a way that the wall thickness is much smaller than the other two dimensions. The ribs are characterized by very high stiffness in their plane and high whippiness in the direction perpendicular to this plane. Inside the profile there are reinforcing steel profiles (Fig. 1).

When a load is applied to the outer bar, stresses arise in its shell, depending on the method of loading. The contact of the outer and inner rods causes the load of the inner rod in the form of bending and torsional moments as well as concentrated normal forces. As the Young's modulus of the PVC jacket is much smaller than the steel material of the inner rod, a significant part of the load is transferred by the steel section. If the resultant of the action of all external forces lying in the section under consideration passes through

a specific point of the section, then the state of load on a bar comes down to its bending only. This particular point of the cross-section is called the center of tangential forces ( $\dot{S}\dot{S}P$  – Fig. 2). Its coordinates in relation to the center of gravity of the cross-section  $O$  are described by the quantities  $e_x$  and  $e_z$  (Fig. 2). In this case, the expense of the tangential stresses  $q_s$  on the long free edge is equal to zero.

In the case of loading window structures, due to the characteristics of their work, they will be loaded primarily with a torsional moment. Therefore, the tangential stresses are dimensioned when turning open sections. The strength condition comes down to the form  $\tau_{\max} < k_t$ . The maximum stresses occur in the extreme layers. In practice, an element is obtained with a high degree of its load on the side surfaces (profile walls). Thus, it shows the necessity of using bars with a tubular cross-section.

During the analysis of the tangential stress state in a thin-walled tubular section, the following assumptions were taken into account [8, 9]:

- Only tangential stresses occur in cross sections.
- The stresses are directed along the perimeter of the cross-section and are constant across the wall thickness of the thin-walled profile.
- The magnitude of the stresses in the walls  $\tau = \text{const}$ .

The resultant cross-sectional load due to the presence of tangential stresses must be equal to the torsional moment  $M_s$ . Thus, determining the moment with respect to any point  $O$  from the resultant tangential stresses  $\tau$  acting on the elementary wall length  $ds$  with the thickness  $t$  and for the moment  $M_0 = M_s$ , the relationship (1) can be written and the stresses can be determined:

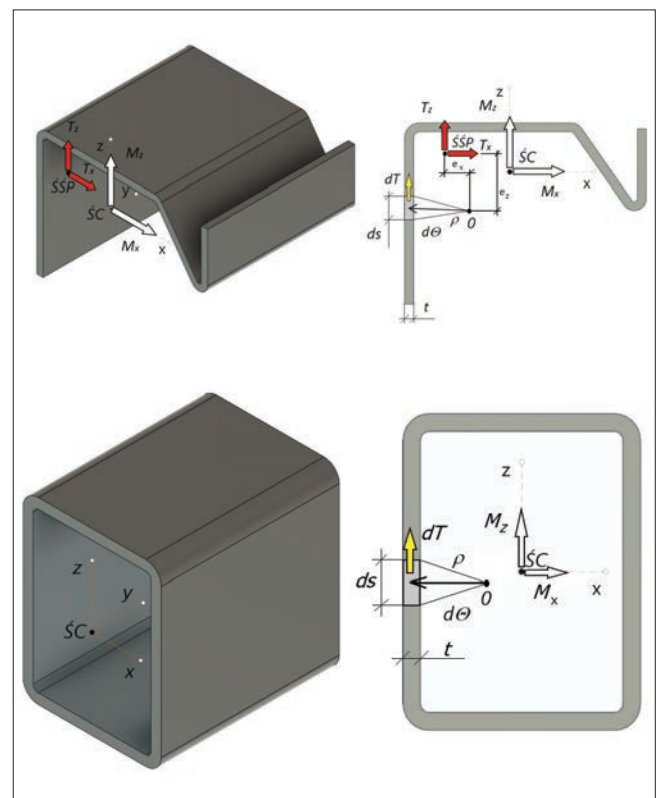

Fig. 2. Loading of the steel bar reinforcing the window frame (closed and open)

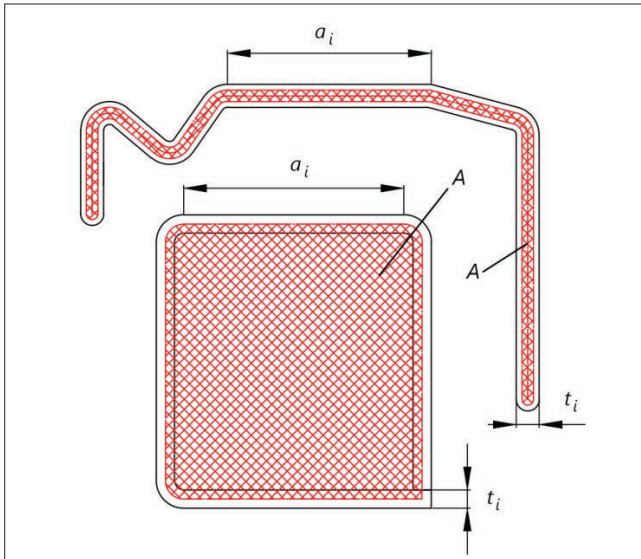

Fig. 3. Interpretation of a twisted section for an open and closed bar

$$M_s = \int_0^s \rho \tau t ds \quad (1)$$

The greatest shear stresses  $\tau_{smax}$  will occur in the place where the wall thickness  $t$  is the smallest:

$$\tau_{smax} = \frac{M_s}{2t_{min}A} \quad (2)$$

where:  $A$  is the area contained within the centreline of the given profile. Interpretation of the area  $A$  for the open and closed sections is shown in Fig. 3. This area is relatively small for the open section, and thus the tangential stresses are very high [1-3].

For closed profiles with a constant wall thickness  $t$ , the tangential stresses are constant and determined from the dependence:

$$\tau_s = \frac{M_s}{2tA} \quad (3)$$

In this case,  $A$  is the area bounded by the mean contour line of the profile. This area is much larger in relation to the  $A$  surface of the open profile, and thus the tangential stresses in the closed profile are several times lower than the stresses for the same open profile. The form (angular) deformation of a closed bar is similar. With the same cross-section, the torsional stiffness of the closed profile is several times (or even several hundred times) greater than that of the open profile, and thus the angular deformation of the closed profile is much smaller than that of the open profile.

It can be concluded that open bars with thin-walled walls work poorly during free torsion. Therefore, it is advisable to use closed profiles which are more technologically complicated and more expensive, but provide high structural rigidity and lower weight. In open profiles, the material is not used at points belonging to the

free surfaces. It is assumed that for the ratio of the linear dimensions of the cross-section  $s/t > 15$  ( $s$  – wall length,  $t$  – wall thickness), such profiles transfer torsion very badly, i.e. high torsional stresses arise even for small moments and it is not advisable to use them in structures twisted.

### Analytical research

Strength calculations of thin-walled open profiles subjected to free torsion are carried out with the simplifying assumption that the cross-section of the bar consists of rectangles with a length  $a_i$  much greater than the thickness  $t_i$ . Moreover, for twisted thin-walled structures with complex shapes, they are divided into rectangles of thickness  $t_i$  and length  $a_i$  (along the contour average line), it does not matter whether the axis of the rectangle is a straight or curved line (Fig. 4). It is also assumed that the torsion angle of the entire bar is equal to the torsion angles of each part of the bar cross-section and the torsional moment transmitted through the entire bar is equal to the algebraic sum of moments transferred by individual rectangles. The open and closed profiles presented below were adopted for consideration.

Generalizing the above equations into profiles of variable thickness, the maximum stresses can be determined from the relationship:

$$\tau_{max} = \frac{M_s}{C} \cdot G \cdot t_{max} \quad (4)$$

$$G = \frac{E}{2 \cdot (1 + \nu) N} \quad (5)$$

$$C = \frac{1}{3} \cdot G \cdot \sum_{i=1} a_i \cdot (t_i)^3 \quad (6)$$

where:  $M_s$  – torsional moment [Nm],  $G$  – rigidity modulus (Kirchhoff modulus) [Pa],  $\nu$  – Poisson's ratio,  $C$  – torsional stiffness of the bar [Nm/rad].

The maximum stresses occur in the middle of the longest side for the thickest rectangle  $t_{max}$ .

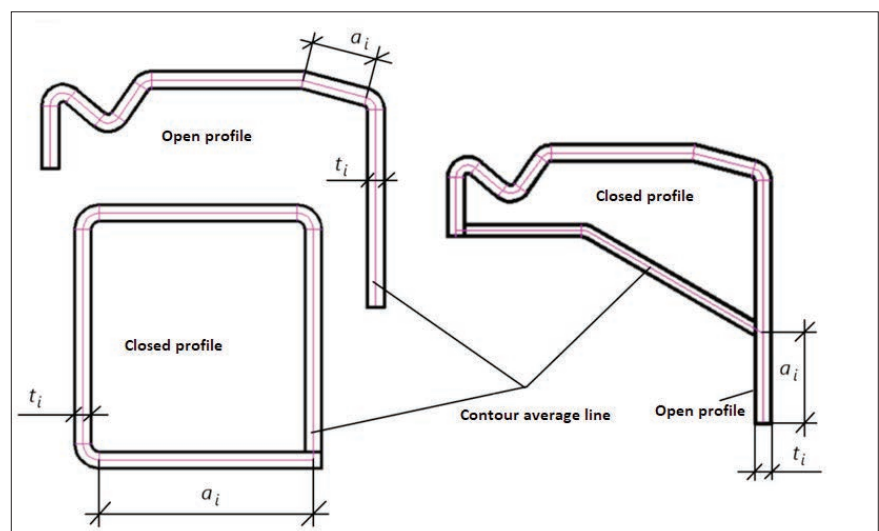

Fig. 4. Computational model of an open and closed profile

In order to compare the strength and stiffness of various structures, the quotient of the maximum shear stresses and the torsional moment  $\tau_{max}/M_s$  (7) and the torsional stiffness  $C$  (6, 7) were analyzed [4-6].

$$\frac{\tau_{max}}{M_s} = \frac{t_{max}}{\frac{1}{3} \cdot \sum_{i=1}^N a_i \cdot (t_i)^3} \quad (7)$$

If  $t_i = t = \text{const}$ , then the expression (7) simplifies to the formula:

$$\frac{\tau_{max}}{M_s} = \frac{1}{\frac{1}{3} \cdot t^2 \cdot \sum_{i=1}^N a_i} \quad (8)$$

On the other hand, for thin-walled closed profiles, based on the hydrodynamic theory, the highest shear stresses will occur in the place where the wall thickness  $t$  is the smallest:

$$\tau_{max} = \frac{M_s}{2 \cdot t_{min} \cdot \int dA} \quad (9)$$

where:  $\int dA$  – surface area limited by the contour line.

The quotient of the maximum shear stresses and the torsional moment  $\tau_{max}/M_s$  equals:

$$\frac{\tau_{max}}{M_s} = \frac{1}{2 \cdot t_{min} \cdot \int dA} \quad (10)$$

The stiffness of a thin-walled closed section is described by the equation:

$$C = 4 \cdot \frac{G \cdot (\int dA)^2}{\oint \frac{ds}{t}} \quad (11)$$

For the case when  $t_i = t = \text{const}$ , the expression (11) simplifies to the form:

$$C = 4 \cdot \frac{G \cdot (\int dA)^2}{\frac{1}{t} \cdot P} \quad (12)$$

where:  $P$  – the length of the perimeter along the average contour line for the profile.

In the conducted theoretical and experimental studies, both open and closed steel profiles were analyzed. As a result, the maximum tangential stresses and profile stiffness were determined, which made it possible to compare these shapes of sections in terms of strength and stiffness. The calculation results for the open profiles are presented in table I.

Table II presents the calculation results for closed profiles joined by welding.

**TABLE I. Strength analysis of steel open profiles with properties  $E = 210 \text{ GPa}$  and  $\nu = 0.3$**

Profile designation	Profile	$\frac{\tau_{max}}{M_s} \left[ \frac{\text{MPa}}{\text{N} \cdot \text{m}} \right]$	$C \left[ \frac{\text{N} \cdot \text{m}}{\text{rad}} \right]$ $\left\{ C \left[ \frac{\text{N} \cdot \text{m}}{\text{deg}} \right] \right\}$
1		26.371	3.06 {0.053}
2		17.003	5.94 {0.104}
3		6.731	24.00 {0.419}
4		10.15	15.91 {0.278}

**TABLE II. Strength analysis of steel closed profiles with properties  $E = 210 \text{ GPa}$  and  $\nu = 0.3$**

Profile designation	Profile	$\frac{\tau_{max}}{M_s} \left[ \frac{\text{MPa}}{\text{N} \cdot \text{m}} \right]$	$C \left[ \frac{\text{N} \cdot \text{m}}{\text{rad}} \right]$ $\left\{ C \left[ \frac{\text{N} \cdot \text{m}}{\text{deg}} \right] \right\}$
5		0.559	2215.9 {38.675}
6		0.358	2954.5 {51.437}
7		0.299	3992.4 {69.681}
8		0.726	1103.1 {19.253}



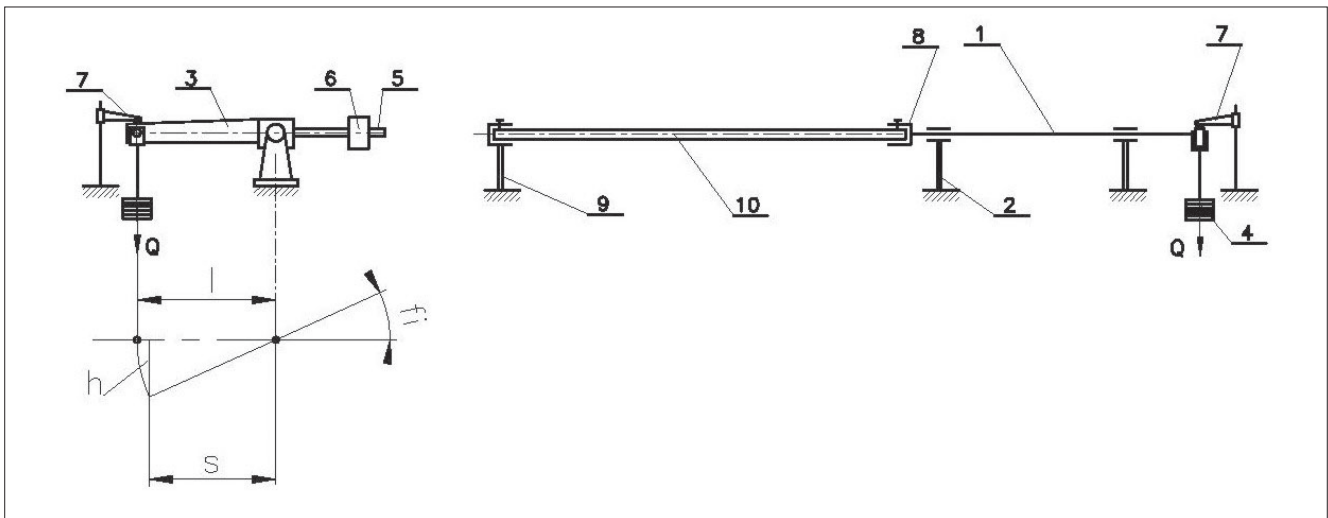

Fig. 5. Layout of the stand for testing the torsional stiffness of profiles

### Experimental research

In order to verify the theoretical considerations in practice, the stiffness of selected sections was tested. Due to their intended use and application in windows where there is a risk of corrosion, sections made of stainless steel type 1.4301 and high-strength steel type HSS were used for the tests with the designation DP 600 [7, 10, 11]. The tests were carried out both on window profiles as well as on complete window muntin and frames with mounted profiles.

The experimental tests were carried out on a specially dedicated test stand, designed and built as part of the project. The layout of the stand is shown in Fig. 5. The stand enables testing of window elements subjected to the action of a torsional moment, and the measurements of displacements and their registration allow the determination of the angle of torsion of the sections and their torsional stiffness. According to the Fig. 5 and Fig. 6, the profile twist angle can be determined from the relationship:

$$\varphi = \arcsin \frac{h}{l} \quad [\text{rad}] \quad (13)$$

The stiffness of a twisted bar is described by the equation:

$$C_s = \frac{M_s}{\varphi} \quad (14)$$

where: torsional moment  $M_s$  was determined from the relationship:

$$M_s = Q\sqrt{l^2 - h^2} \quad (15)$$

In the designated stand, the following dimensions were adopted:  $l = 250$  mm, the length of the measured bar  $L = 1000$  mm,  $Q$  - loading force.

As a result of the experimental studies, the stiffness characteristics and the dependence of the torsion angle on the torsional moment  $M_s$  were determined for individual cross-sections. For all comparative tests, bars with a twisted length of 1 m were used.

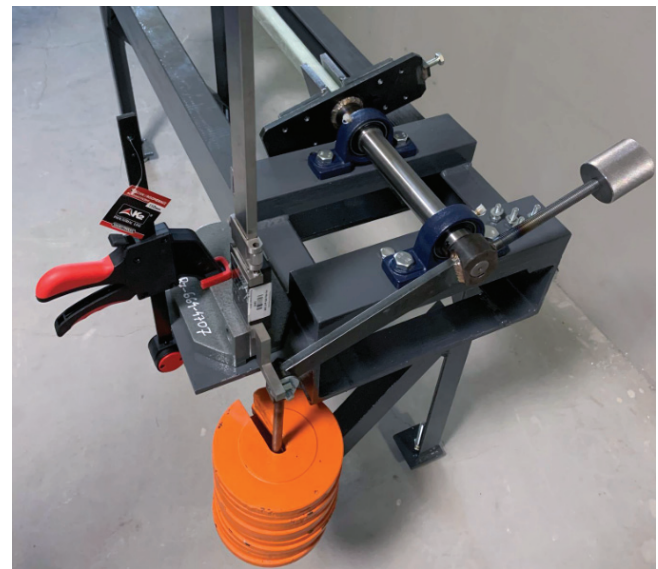

Fig. 6. An example of testing a closed window profile

Closed metal bars were made using open bars and closed them with a butt joint, intermittent weld with a thickness equal to the thickness of the joined sheets, length  $l = 50$  mm and pitch  $p = 50$  mm. Torsion diagrams and the obtained maximum stiffness values are shown in the Fig. 7.

### Conclusions

Open bars show much lower torsional stiffness compared to closed bars with contour dimensions and identical wall thicknesses (even several hundred times smaller). The stiffness of open bars can be increased, first of all, by increasing the wall thickness of the sections. However, this leads to a significant increase in the weight of the structure and an increase in its price. The conducted research shows that the highest torsional stiffness is shown by a "3" cross-section bar, which is at least twice as stiffer than other profiles. It is pointless to use thin-walled open profiles of the "1" type in the construction of windows (table I). Torsion diagrams of the tested open profiles in the entire load range behaved in a linear manner.

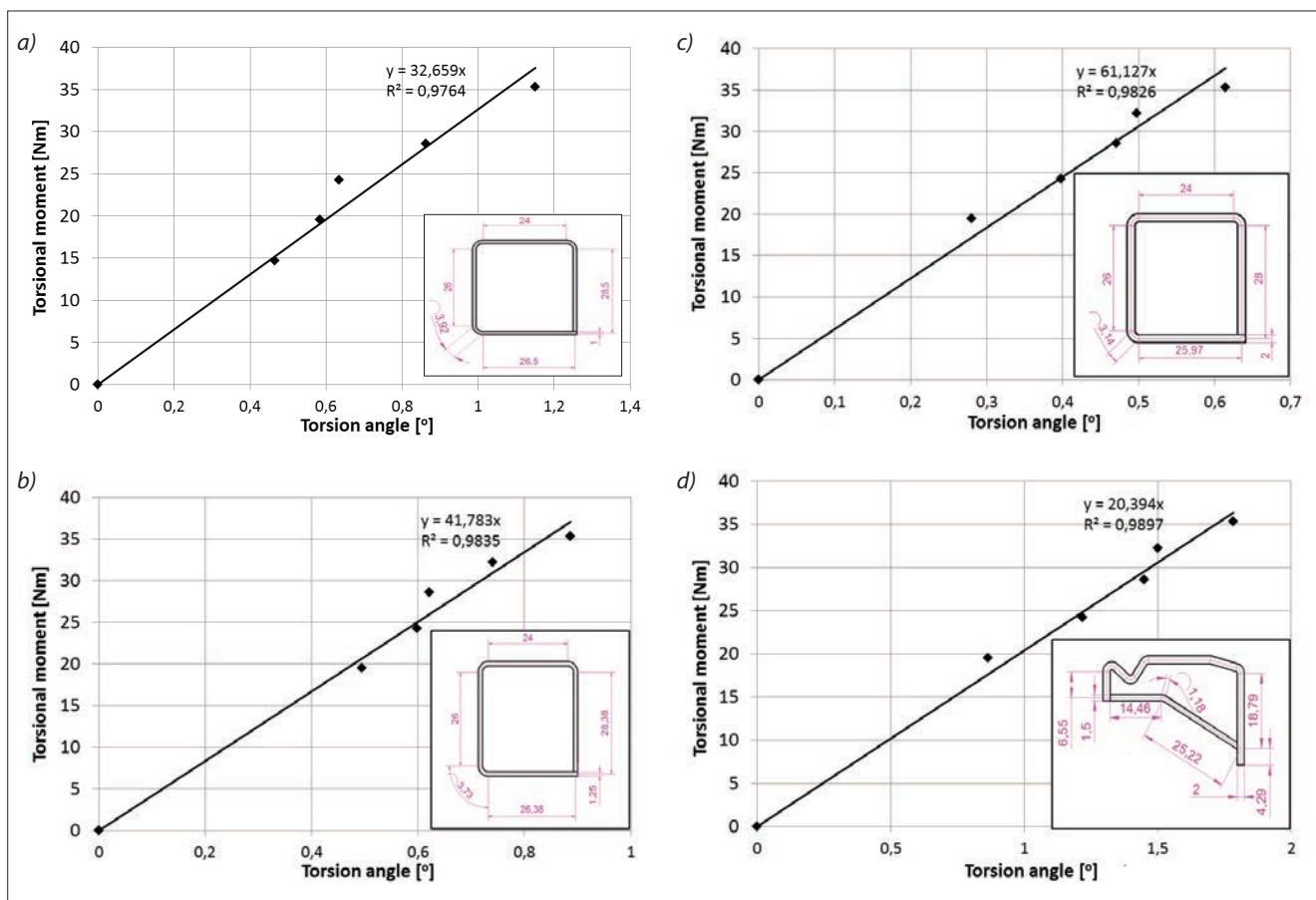

Fig. 7. Torsion diagrams and the obtained maximum stiffness values

Closed bars show much higher torsional stiffness in comparison to open profiles of identical dimensions (from several dozen to several hundred times greater). It is therefore expedient to use closed profiles. The torsional strength of closed bars in relation to identical bars with an open section is up to several dozen times higher (up to 30 times in the conducted tests). Closed bars have a non-linear stiffness characteristic. After exceeding a certain torsion angle (approx.  $10^\circ$ ), they significantly reduce their ability to transmit high torsional moments. All the discussed profiles are made of steel. Therefore, they are heavy and tend to corrode, which reduces the quality of windows during operation. In order to eliminate this disadvantage, it would be necessary to use corrosion-resistant steel or closed profiles made of glass-fiber reinforced composites. The use of closed profiles is particularly justified in the production of construction joinery with large dimensions subjected to high wind loads.

### Acknowledgements

This paper was inspired by the work carried out under grant RPPK.01.02.00 – 18 – 0033/18 – 00 entitled: „Opracowanie i wdrożenie do produkcji innowacyjnej konstrukcji okna minimalizującej liniowe mostki termiczne wraz ze zwiększoną odpornością na odkształcenia mechaniczne”, co-financed by European Regional Development Fund.

### REFERENCES

- [1] PN-B-02011:1977 – Obciążenia w obliczeniach statycznych – Obciążenie wiatrem.
- [2] PN-EN 12210:2001 – Okna i drzwi – Odporność na obciążenie wiatrem – Klasyfikacja.
- [3] PN-EN 12211:2001 – Okna i drzwi – Odporność na obciążenie wiatrem – Metoda badań.
- [4] PN-B-10085:/Az2:1997 – Stolarka budowlana – Okna i drzwi – Wymagania i badania.
- [5] BN - 75/7150 - 03 – Okna i drzwi balkonowe drewniane – Metody badań.
- [6] Instrukcja ITB 224 – Wymagania techniczno-użytkowe dla lekkich ścian osłonowych w budownictwie ogólnym.
- [7] Bergstrom U., Bronnestam M., Gustafsson L., Ingvarsson L., Setter B. „Sheet Steel Handbook – Design and fabrication in high strength steel”. Borlange, Sweden: SSAB, 1996, Tunnplant, 5:12-5:27.
- [8] Brzoska Z. „Statyka i stateczność konstrukcji prętowych i cienkościennych”. Warszawa: PWN, 1965.
- [9] Gosowski B. „Zginanie i skręcanie cienkościennych elementów konstrukcji metalowych”. Wrocław: Oficyna Wydawnicza Politechniki Wrocławskiej, 2015.
- [10] Bałon P., Świętoniowski A. “Springback compensation in cold forming process for high strength steel”. *Archives of Metallurgy and Materials*. Polish Academy of Sciences. Committee of Metallurgy, Institute of Metallurgy and Materials Science. 4, 60 (2015): 2471–2478, <https://doi.org/10.1515/amm-2015-0401>.
- [11] Troive L., Bałon P., Świętoniowski A., Mueller T., Kiełbasa B. “Springback compensation for a vehicle’s steel body panel”. *International Journal of Computer Integrated Manufacturing*. 31, 2 (2018): 152–163, <https://doi.org/10.1080/0951192X.2017.1379096>.